

Precision Monolithics Inc.

FEATURES

- **Low Supply Current** **600 μ A Max**
- **Low Offset Voltage** **120 μ V Max**
- **Low Drift** **1.5 μ V/ $^{\circ}$ C Max**
- **Very Low Bias Current**
 25 $^{\circ}$ C **100pA Max**
 -55 $^{\circ}$ C to +125 $^{\circ}$ C **600pA Max**
- **Low Noise** **0.5 μ V_{p-p} Typ**
- **High Common-Mode Rejection** **114dB Min**

ORDERING INFORMATION†

V _{OS} (μ V)	PACKAGE			OPERATING TEMPERATURE RANGE
	TO-99 8-PIN	HERMETIC DIP 8-PIN	PLASTIC DIP 8-PIN	
120	PM1008AJ*	PM1008AZ*	—	MIL
120	PM1008GJ	PM1008GZ	PM1008GP	COM

*For devices processed in total compliance to MIL-STD-883, add /883 after part number. Consult factory for 883 data sheet.

†Burn-in is available on commercial and industrial temperature range parts in cerdip, plastic dip, and TO-can packages. For ordering information, see 1988 Data Book, Section 2.

GENERAL DESCRIPTION

The PM-1008 is a general-purpose, externally-compensated precision operational amplifier. AC performance of the PM-1008 matches that of 108A/308A type amplifiers, while DC precision is greatly improved. Exceptionally low bias currents of only

± 80 pA, typical, over the full military temperature range combine with low noise of only $17\text{nV}/\sqrt{\text{Hz}}$ at 10Hz. The PM-1008's low offset voltage of 120 μ V maximum frees the user from external nulling in most circuits.

An open-loop gain of two million into a 10k Ω load ensures that excellent linearity is maintained even in high-gain configurations, and 5mA of output current allows 2k Ω loads to be driven with an open-loop gain of 600V/mV. High gain and 132dB of common-mode rejection and power-supply rejection eliminates the need for many tedious error calculations.

External frequency compensation allows the PM-1008's AC response to be optimized for each application. The PM-1008 will

PIN CONNECTIONS

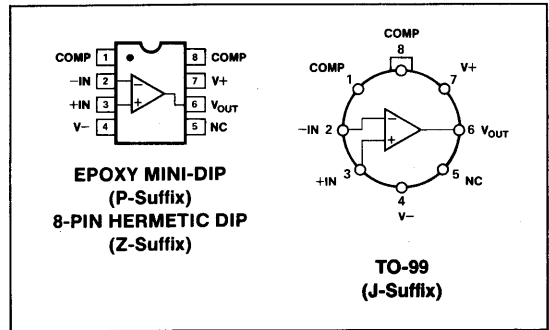

SIMPLIFIED SCHEMATIC

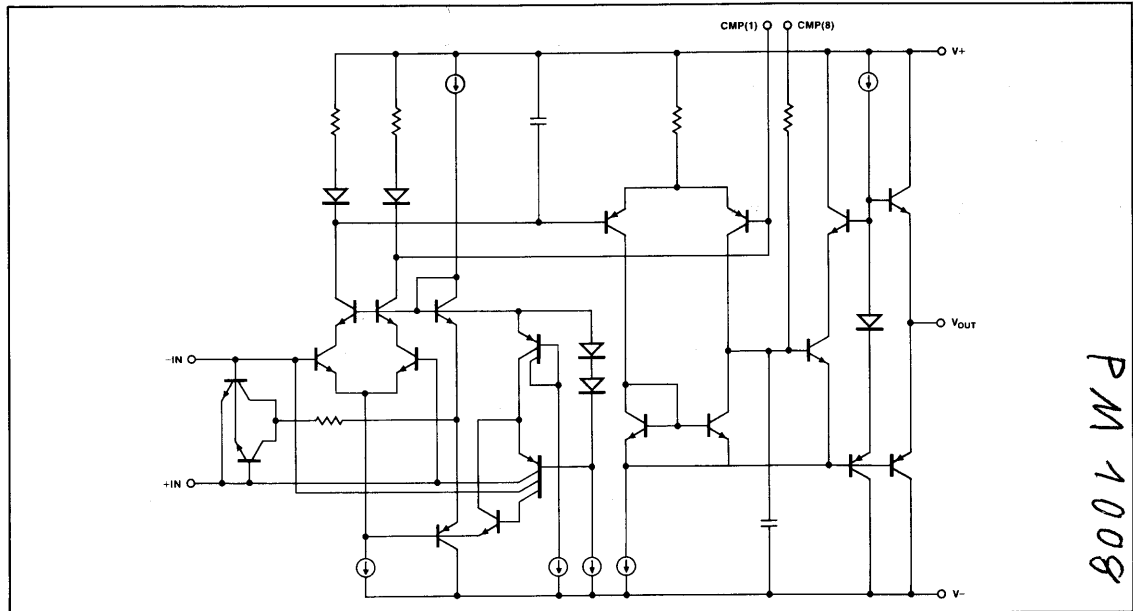



directly upgrade 108A/308A and OP-08 sockets without modifying compensation. Compensation is usually achieved with a single capacitor, although more complex schemes may be used to further tailor the amplifier's response for a particular circuit.

For an internally compensated unity-gain stable amplifier with improved DC precision, see the OP-97 data sheet.

ABSOLUTE MAXIMUM RATINGS (Note 1)

Supply Voltage	±20V
Internal Power Dissipation (Note 2)	500mW
Input Voltage (Note 3)	±20V
Differential Input Voltage (Note 4)	±1V
Differential Input Current (Note 4)	±10mA
Output Short-Circuit Duration	Indefinite
Operating Temperature Range	
PM1008A (J, Z)	-55°C to +125°C
PM1008G (J, Z, P)	0°C to 70°C

Storage Temperature Range	-65°C to 150°C
Junction Temperature Range	-65°C to 150°C
Lead Temperature (Soldering, 10 sec)	300°C

NOTES:

1. Absolute maximum ratings apply to both DICE and packaged parts, unless otherwise noted.
2. See table for maximum ambient temperature and rating.

PACKAGE TYPE	MAXIMUM AMBIENT TEMPERATURE FOR RATING	DERATE ABOVE MAXIMUM AMBIENT TEMPERATURE
TO-99 (J)	80°C	7.1mW/°C
8-Pin Hermetic DIP (Z)	75°C	6.7mW/°C
8-Pin Plastic DIP (P)	62°C	5.6mW/°C

3. For supply voltages less than ±20V, the absolute maximum input voltage is equal to the supply voltage.
4. The PM-1008's inputs are protected by back-to-back diodes. Current-limiting resistors are not used in order to achieve low noise. Differential input voltages greater than 1V will cause excessive current to flow through the input protection diodes unless limiting resistance is used.

ELECTRICAL CHARACTERISTICS at $V_S = \pm 15V$, $V_{CM} = 0V$, $C_F = 30pF$, $T_A = 25^\circ C$ unless otherwise noted.

PARAMETER	SYMBOL	CONDITIONS	PM-1008A			PM-1008G			UNITS
			MIN	TYP	MAX	MIN	TYP	MAX	
Input Offset Voltage	V_{OS}	(Note 1)	—	30	120	—	30	120	μV
			—	40	180	—	40	180	
Long-Term V_{OS} Stability	$\Delta V_{OS}/\text{Time}$		—	0.3	—	—	0.3	—	$\mu V/\text{month}$
Input Offset Current	I_{OS}	(Note 1)	—	30	100	—	30	100	pA
			—	40	150	—	40	150	
Input Bias Current	I_B	(Note 1)	—	±30	±100	—	±30	±100	pA
			—	±40	±150	—	±40	±150	
Input Noise Voltage	e_{n-p-p}	0.1Hz to 10Hz	—	0.5	—	—	0.5	—	μV_{p-p}
Input Noise Voltage Density	e_n	$f_o = 10\text{Hz}$ (Note 3) $f_o = 1000\text{Hz}$ (Note 4)	—	17	30	—	17	30	$nV/\sqrt{\text{Hz}}$
			—	14	22	—	14	22	
Input Noise Current Density	i_n	$f_o = 10\text{Hz}$	—	20	—	—	20	—	$fA/\sqrt{\text{Hz}}$
Large-Signal Voltage Gain	A_{VO}	$V_O = \pm 12V$; $R_L = 10k\Omega$ $V_O = \pm 10V$; $R_L = 2k\Omega$	200	2000	—	200	2000	—	V/mV
			120	600	—	120	600	—	
Common-Mode Rejection	CMR	$V_{CM} = \pm 13.5V$	114	132	—	114	132	—	dB
Power-Supply Rejection	PSR	$V_S = \pm 2V$ to $\pm 20V$	114	132	—	114	132	—	dB
Input Voltage Range	IVR	(Note 2)	±13.5	±14.0	—	±13.5	±14.0	—	V
Output Voltage Swing	V_O	$R_L = 10k\Omega$	±13	±14	—	±13	±14	—	V
Slew Rate	SR		0.1	0.2	—	0.1	0.2	—	V/ μs
Full-Power Bandwidth	BW _p		—	3	—	—	3	—	kHz
Gain-Bandwidth Product	GBW	$A_v = 100$	—	0.5	—	—	0.5	—	MHz
Supply Current	I_{SY}	(Note 1)	—	380	600	—	380	600	μA
Supply Voltage	V_S	Operating Range	±2	±15	±20	±2	±15	±20	V

NOTES:

1. These specifications apply for $\pm 2V \leq V_S \leq \pm 20V$ and $-13.5V \leq V_{CM} \leq +13.5V$ (for $V_S = \pm 15V$).
2. Guaranteed by CMR test.
3. 10Hz noise voltage density is sample tested. Devices 100% tested for noise are available on request.
4. Sample tested.

ELECTRICAL CHARACTERISTICS at $V_S = \pm 15V$, $V_{CM} = 0V$, $C_F = 30pF$, $0^\circ C \leq T_A \leq 70^\circ C$ for the PM1008G and $-55^\circ C \leq T_A \leq 125^\circ C$ for the PM-1008A, unless otherwise noted.

PARAMETER	SYMBOL	CONDITIONS	PM-1008A			PM-1008G			UNITS
			MIN	TYP	MAX	MIN	TYP	MAX	
Input Offset Voltage	V_{OS}	(Note 1)	—	50	250	—	40	180	μV
Average Temperature Coefficient of V_{OS}	TCV_{OS}		—	0.2	1.5	—	0.2	1.5	$\mu V/^\circ C$
Input Offset Current	I_{OS}	(Note 1)	—	60	250	—	40	180	μA
Average Temperature Coefficient of I_{OS}	TCI_{OS}		—	80	350	—	50	250	$\mu A/^\circ C$
Input Bias Current	I_B	(Note 1)	—	± 80	± 600	—	± 40	± 180	μA
Average Temperature Coefficient of I_B	TCI_B		—	± 150	± 800	—	± 50	± 250	$\mu A/^\circ C$
Large-Signal Voltage Gain	A_{VO}	$V_O = \pm 12V$; $R_L = 10k\Omega$	100	1000	—	150	1500	—	V/mV
Common-Mode Rejection	CMR	$V_{CM} = \pm 13.5V$	108	128	—	110	130	—	dB
Power-Supply Rejection	PSR	$V_S = \pm 2.5V$ to $\pm 20V$	108	126	—	110	128	—	dB
Input Voltage Range	IVR	(Note 2)	± 13.5	± 14.0	—	± 13.5	± 14.0	—	V
Output Voltage Swing	V_O	$R_L = 10k\Omega$	± 13	± 14	—	± 13	± 14	—	V
Slew Rate	SR		0.05	0.15	—	0.05	0.15	—	V/ μs
Supply Current	I_{SY}	(Note 1)	—	400	800	—	400	800	μA
Supply Voltage	V_S	Operating Range	± 2.5	± 15	± 20	± 2.5	± 15	± 20	V

NOTES:

- These specifications apply for $\pm 2.5V \leq V_S \leq \pm 20V$ and $-13.5V \leq V_{CM} \leq +13.5V$ (for $V_S = \pm 15V$).
- Guaranteed by CMR test.

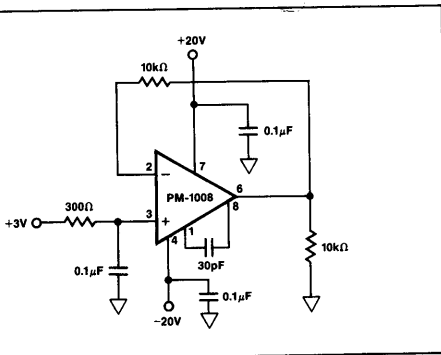
BURN-IN CIRCUIT

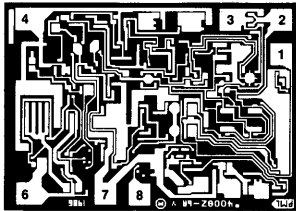
DICE CHARACTERISTICS

DIE SIZE 0.054 × 0.074 inch, 3996 sq. mils
(1.37 × 1.88 mm, 2.58 sq. mm)

1. COMPENSATION
2. INVERTING INPUT
3. NONINVERTING INPUT
4. V⁻
6. OUTPUT
7. V⁺
8. COMPENSATION

For additional DICE ordering information, refer to 1988 Data Book, Section 2.

WAFER TEST LIMITS at $V_S = \pm 15V$, $V_{CM} = 0V$, $C_F = 30pF$, $T_A = 25^\circ C$ unless otherwise noted.

PARAMETER	SYMBOL	CONDITIONS	PM-1008N	UNITS
			LIMIT	
Input Offset Voltage	V_{OS}	(Note 1)	120	μV MAX
			180	
Input Offset Current	I_{OS}	(Note 1)	100	pA MAX
			150	
Input Bias Current	I_B	(Note 1)	± 100	pA MAX
			± 150	
Large-Signal Voltage Gain	A_{VO}	$V_{OUT} = \pm 12V$, $R_L = 10k\Omega$	200	V/mV MIN
		$V_{OUT} = \pm 10V$, $R_L = 2k\Omega$	120	
Common-Mode Rejection	CMR	$V_{CM} = \pm 13.5V$	114	dB MIN
Power-Supply Rejection	PSR	$V_S = \pm 2V$ to $\pm 20V$	114	dB MIN
Input-Voltage Range	IVR	(Note 2)	± 13.5	V MIN
Output Voltage Swing	V_O	$R_L = 10k\Omega$	± 13	V MIN
Slew Rate	SR		0.1	V/ μs MIN
Supply Current	I_{SY}	No Load	600	μA MAX

NOTES:

1. These specifications apply for $\pm 2V \leq V_S \leq \pm 20V$ and $-13.5V \leq V_{CM} \leq +13.5V$ (for $V_S = \pm 15V$).
2. Guaranteed by CMR test.

Electrical tests are performed at wafer probe to the limits shown. Due to variations in assembly methods and normal yield loss, yield after packaging is not guaranteed for standard product dice. Consult factory to negotiate specifications based on dice lot qualification through sample lot assembly and testing.

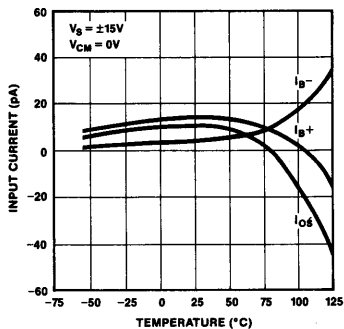
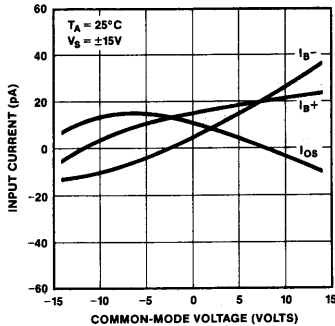
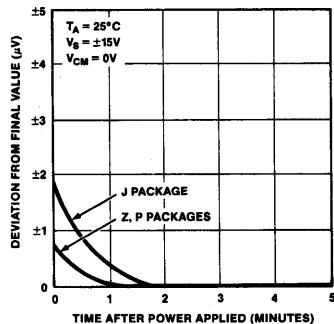
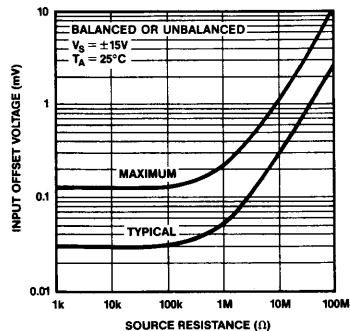
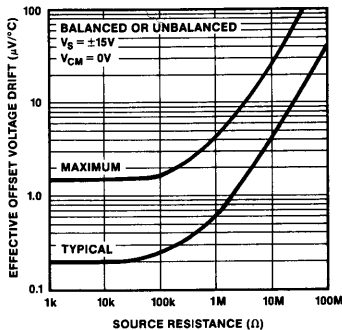
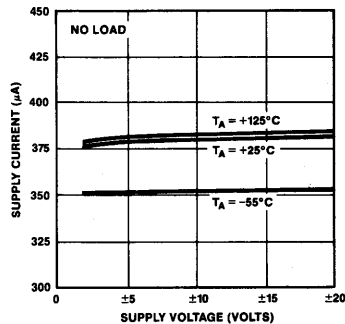
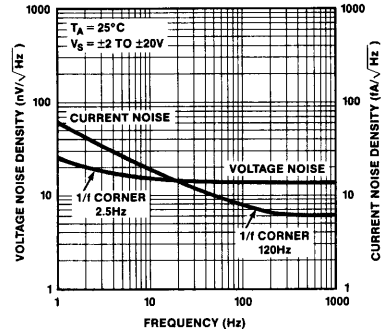
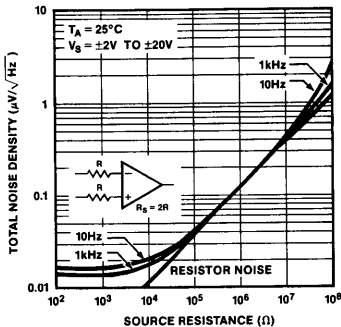
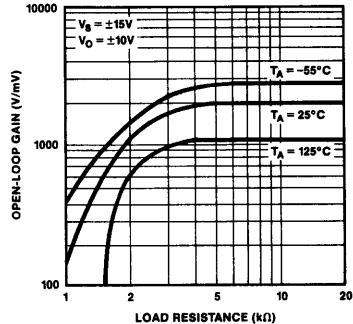
TYPICAL PERFORMANCE CHARACTERISTICS
INPUT BIAS, OFFSET CURRENT vs TEMPERATURE

INPUT BIAS, OFFSET CURRENT vs COMMON-MODE VOLTAGE

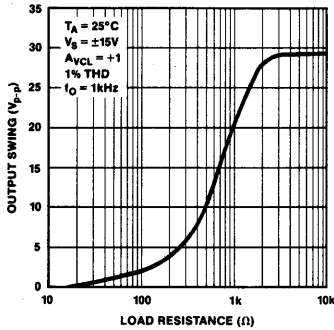
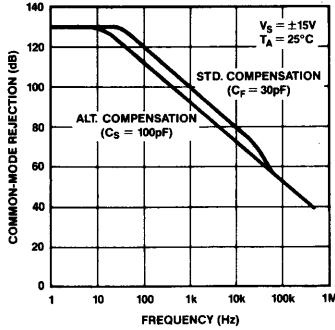
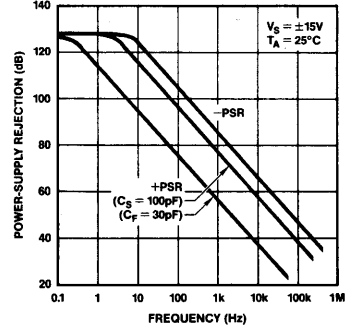
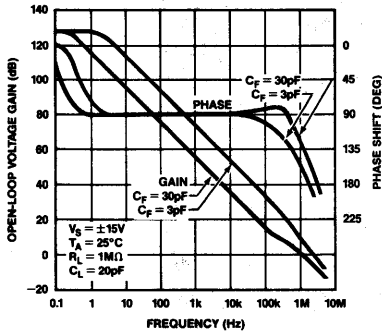
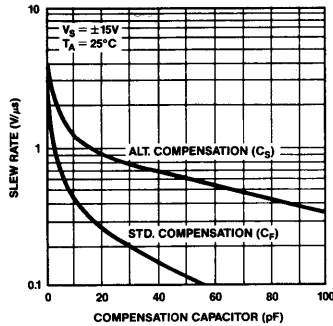
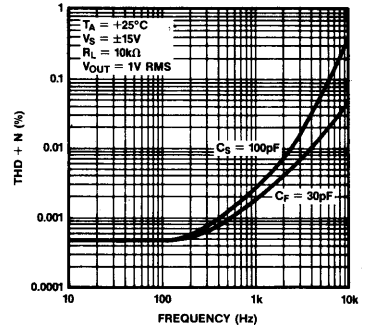
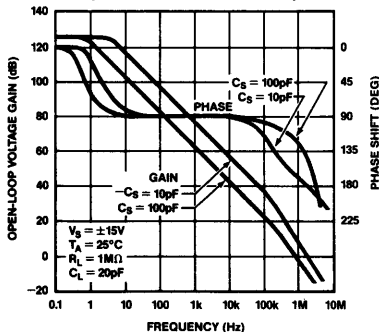
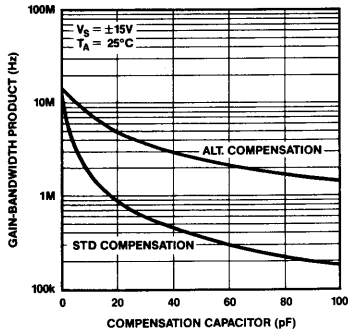
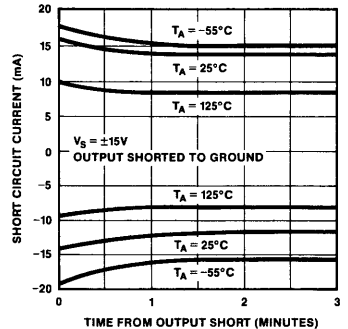
INPUT OFFSET VOLTAGE WARM-UP DRIFT

EFFECTIVE OFFSET VOLTAGE vs SOURCE RESISTANCE

EFFECTIVE TCV_{OS} vs SOURCE RESISTANCE

SUPPLY CURRENT vs SUPPLY VOLTAGE

NOISE DENSITY vs FREQUENCY

TOTAL NOISE DENSITY vs SOURCE RESISTANCE

OPEN-LOOP GAIN vs LOAD RESISTANCE

TYPICAL PERFORMANCE CHARACTERISTICS

MAXIMUM OUTPUT SWING vs LOAD RESISTANCE

COMMON-MODE REJECTION vs FREQUENCY

POWER-SUPPLY REJECTION vs FREQUENCY

OPEN-LOOP GAIN, PHASE vs FREQUENCY (STD. COMPENSATION)

SLEW RATE vs COMPENSATION

TOTAL HARMONIC DISTORTION PLUS NOISE vs FREQUENCY

OPEN-LOOP GAIN, PHASE vs FREQUENCY (ALT. COMPENSATION)

GAIN-BANDWIDTH PRODUCT vs COMPENSATION

SHORT-CIRCUIT CURRENT vs TIME, TEMPERATURE

APPLICATIONS INFORMATION

The PM-1008 is an externally compensated amplifier for use in circuits where precision is critical, yet power dissipation must be minimized. An upgrade to the OP-08 and 108A type amplifiers, the PM-1008 offers exceptional performance for a low-power amplifier. Its wide supply range coupled with minimal current drain makes it an excellent choice for battery-powered and portable instruments. External compensation allows the maximum bandwidth to be achieved with any given gain.

Input bias and offset currents remain extremely low over the full military temperature range, and make the PM-1008 attractive in a variety of logging circuits and peak detectors. Balancing of input resistances is not necessary with the PM-1008. Offset voltage and TCV_{OS} are degraded only minimally by high source resistance, even when unbalanced.

The input pins of the PM-1008 are protected against large differential voltages by back-to-back diodes. To preserve low-noise performance, current limiting resistors are not used in the inputs. If differential voltages above $\pm 1V$ are expected at the inputs, series resistors must be used to limit the current flow to a maximum of 10mA. Common-mode voltages at the inputs are not restricted and may vary over the full range of the supply voltages used.

The PM-1008 requires very little operating headroom about the supply rails and is specified for operation with supplies as low as $\pm 2V$. Typically, the common-mode range extends to within one volt of either rail. The output typically swings to within one volt of the rails when driving a 10k Ω load.

FREQUENCY COMPENSATION

A high degree of flexibility in shaping the AC response of the amplifier to specific applications is achieved with two compensation pins. Compensation usually consists of a single capacitor and is achieved using the same circuits as the OP-08 or 108A type amplifiers. The PM-1008 will directly upgrade these sockets to obtain increased DC precision with similar AC performance.

Standard compensation using the circuit of Figure 1 introduces feedback in the second stage. The feedback capacitor must be greater than $(R1 \times 30pF)/(R1 + R2)$ to ensure stability. Figure 2 shows the large-signal and small-signal response of the PM-1008 using standard compensation.

FIGURE 1: Standard Frequency Compensation

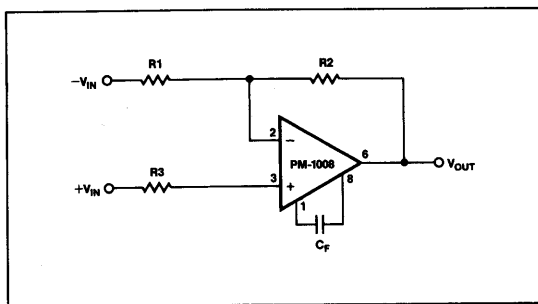
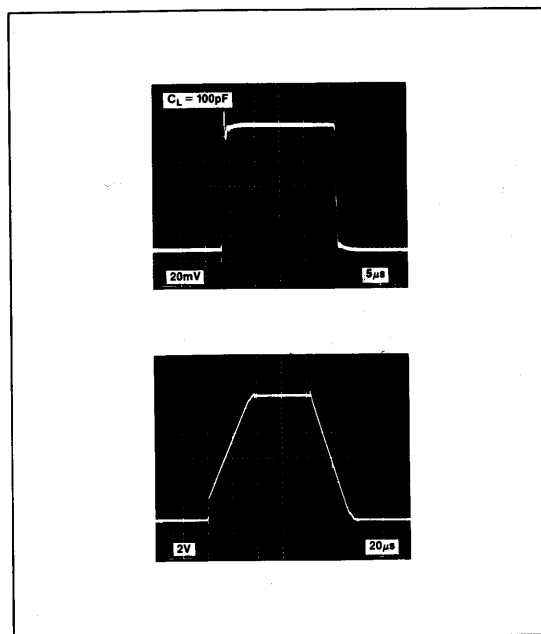

FIGURE 2: Standard Compensation Transient Response ($C_F = 30pF$, $A_{VCL} = +1$)



The alternate compensation method of Figure 3 improves AC power-supply rejection by a factor of five. This is an advantage in circuits where digital noise is injected onto supply lines, or noisy switching power-supplies are used. Figure 4 depicts transient response with alternate compensation.

Bandwidth and slew rate are inversely proportional to the compensation capacitor, regardless of which method used. Compensation with $C_F = 30\text{pF}$ results in AC performance similar to the internally compensated OP-97. Phase margin is approximately 60 degrees. Additional compensation will result in increased stability useful for circuits with capacitive loads, or with gain in the feedback loop. Overcompensation reduces overall noise by limiting bandwidth. Less compensation is useful to obtain higher bandwidth and slew rate with higher closed-loop gains. External compensation is not required for closed-loop gains greater than 200.

In unity-gain large-signal applications, the input protection diodes effectively short the output to the input during transients

in the usual unity-gain configuration. The output enters short-circuit current limit, with the flow going through the protection diodes. Improved transient response is obtained by using a feedback resistor (R_2) between the output and the inverting input to limit this current. The preceding large-signal photos used a $10\text{k}\Omega$ feedback resistor, R_2 , with $R_1 = R_3 = 0$.

Feedforward compensation may be used in low-gain applications to enhance slew rate. The inverting circuit of Figure 5 has a slew rate of $1.4\text{V}/\mu\text{s}$, while the follower circuit of Figure 7 approaches $10\text{V}/\mu\text{s}$. Inverting feedforward compensation does not degrade the accuracy of the PM-1008, and can be valuable in many applications. Follower feedforward compensation may introduce errors if the output is loaded, even with $10\text{k}\Omega$. It should be used with care to ensure that performance is not compromised.

FIGURE 3: Alternate Frequency Compensation

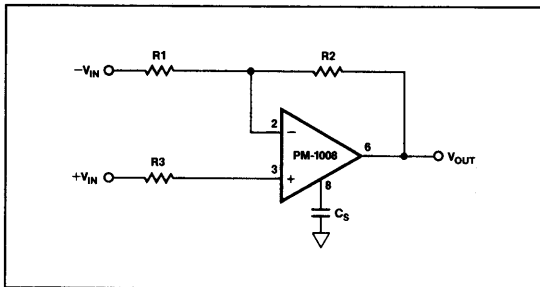

FIGURE 5: Inverter Feedforward Compensation

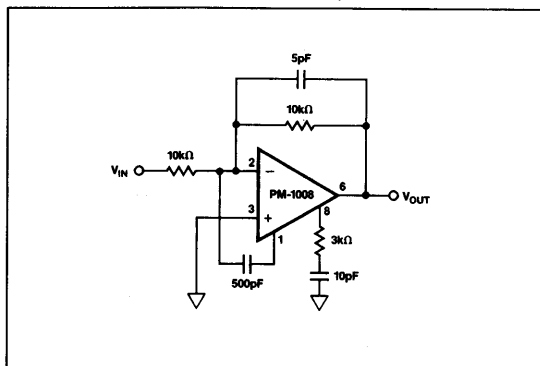

FIGURE 4: Alternate Frequency Compensation Transient Response ($C_S = 100\text{pF}$, $A_{VCL} = +1$)

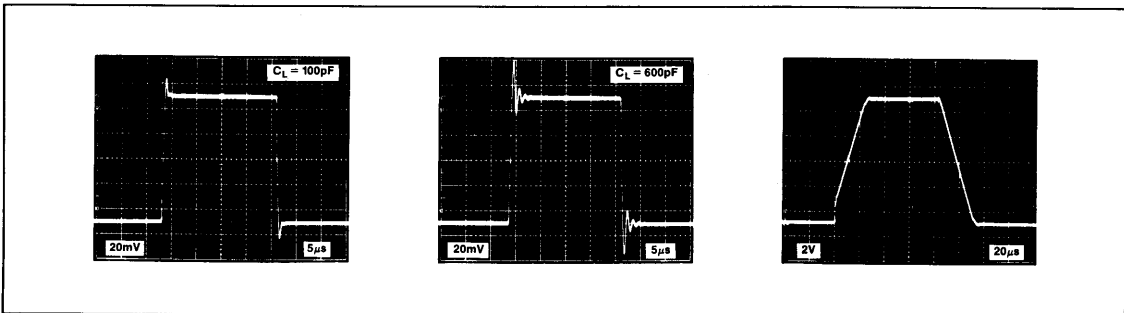
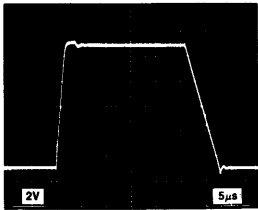
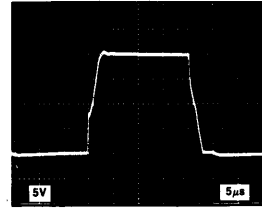
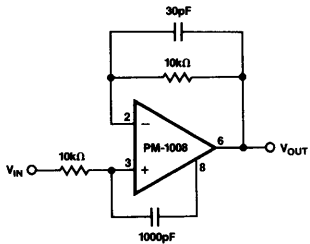
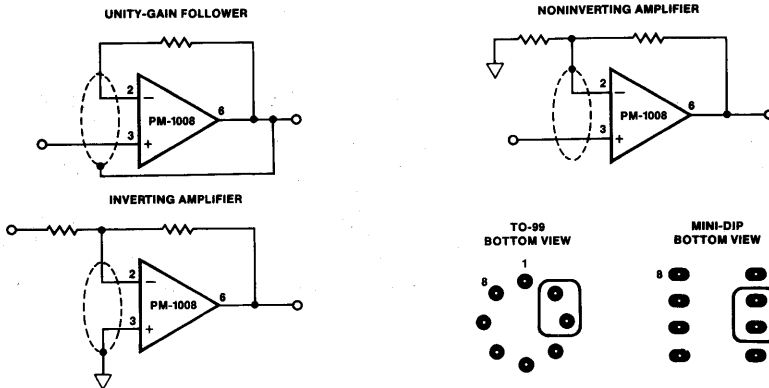

FIGURE 6: Inverter Feedforward Transient Response

FIGURE 8: Follower Feedforward Transient Response

FIGURE 7: Follower Feedforward Compensation

GUARDING AND SHIELDING

To maintain the extremely high input impedances of the PM-1008, care must be taken in circuit board layout and manufacturing. Board surfaces must be kept scrupulously clean and free of moisture. Conformal coating is recommended to provide a humidity barrier. Even a clean PC board can have 100pA of leakage currents between adjacent traces, so that guard rings should be used around the inputs. Guard traces are operated at a voltage close to that on the inputs, so that leakage currents become minimal. In noninverting applications, the guard ring should be connected to the common-mode voltage at the inverting input (pin 2). In inverting applications, both inputs remain at ground, so that the guard trace should be grounded. Guard traces should be made on both sides of the circuit board.

FIGURE 9: Guard Ring Layout and Connections

High impedance circuitry is extremely susceptible to RF pickup, line-frequency hum and radiated noise from switching power-supplies. Enclosing sensitive analog sections within grounded shields is generally necessary to prevent excessive noise pickup. Twisted-pair cable will aid in rejection of line-frequency hum.

The circuit of Figure 10 multiplies capacitor values by a factor of $(R1/R3)$. Equivalent leakage of the capacitance multiplier is much smaller than that available with extremely large capacitors. The equivalent leakage current is determined by the offset voltage and offset currents of the amplifier used, both of which are quite low with the PM-1008, even over temperature. The equivalent series resistance of the multiplied capacitor is $R3$, which prevents the circuit from generated high-Q capacitances. In timing circuits where a series resistance is connected with the capacitor, $R3$ should be considered a part of that resistance.

FIGURE 10: Capacitance Multiplier

FIGURE 11: Photodiode Amplifier

FIGURE 12: Zero-Crossing Detector

Figure 11 shows an amplifier for photodiodes. The diode is operated with only the V_{OS} of the amplifier as bias. Thus, the diode's leakage currents remain minimal even at high temperatures. The capacitor in the feedback loop acts to prevent gain peaking at high frequencies due to the diode capacitance.

The output swing of the PM-1008 may be clamped to specific levels using pin 8. The zero-crossing detector of Figure 12 uses a zener diode to clamp the maximum positive swing to approximately 5V, and the maximum negative swing to the forward-biased voltage drop across the diode. R_{IN} limits the current-flow through the protection diodes for voltage excursions beyond $\pm 1V$. With $R_{IN} = 1M\Omega$, the circuit will tolerate as much as 1kV at the input.

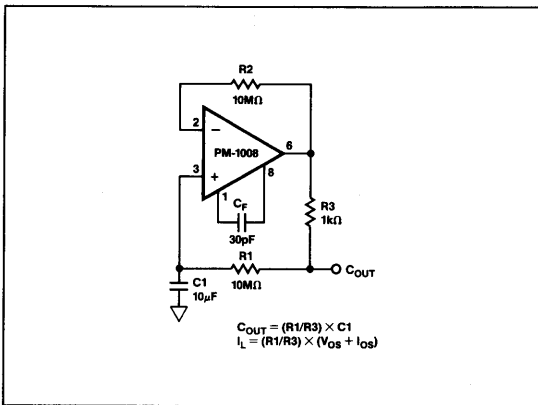
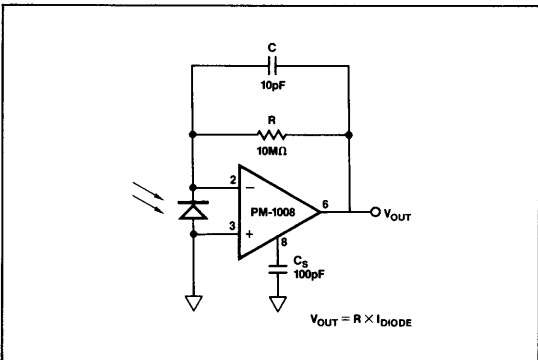
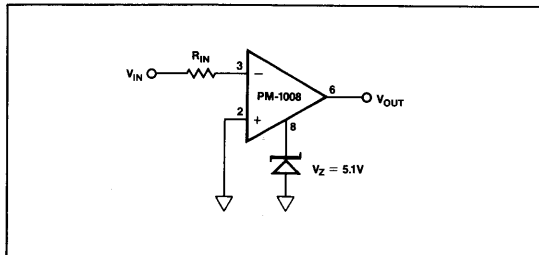
The logarithmic amplifier in Figure 13 eliminates thermal drift caused by temperature dependencies of the logging transistors by maintaining a monolithic quad matched transistor at a predetermined temperature. The MAT-04 has four transistors laid-out at the corners of a square die. Two transistors across a diagonal are used for logging elements. One of the remaining transistors is used as a heater to maintain a constant chip temperature, and the remaining transistor, diagonally opposite to the heater, is used as a temperature sensor.

The OP-90 servo amplifier uses thermal feedback to set the temperature of the MAT-04 die. The base-to-emitter voltage of Q2 is maintained at the level set by the resistive divider from the REF-01, by controlling the current flowing through Q4. Although Q4 may operate beyond the MAT-04's rated levels, this does not degrade operation since the characteristics of the heater transistor are non-critical. For best thermal regulation, the MAT-04 package should be encased in insulation. Urethane foam used for housing insulation is excellent for this purpose.

Gain is trimmed using the 2kΩ potentiometer. The zero-crossing point is adjusted by changing the value of R_{REF} . Input scaling may be changed by varying resistor R_{IN} .

FIGURE 13: Logarithmic Amplifier with Heated Logging Transistors
